

ABCs of God's Word

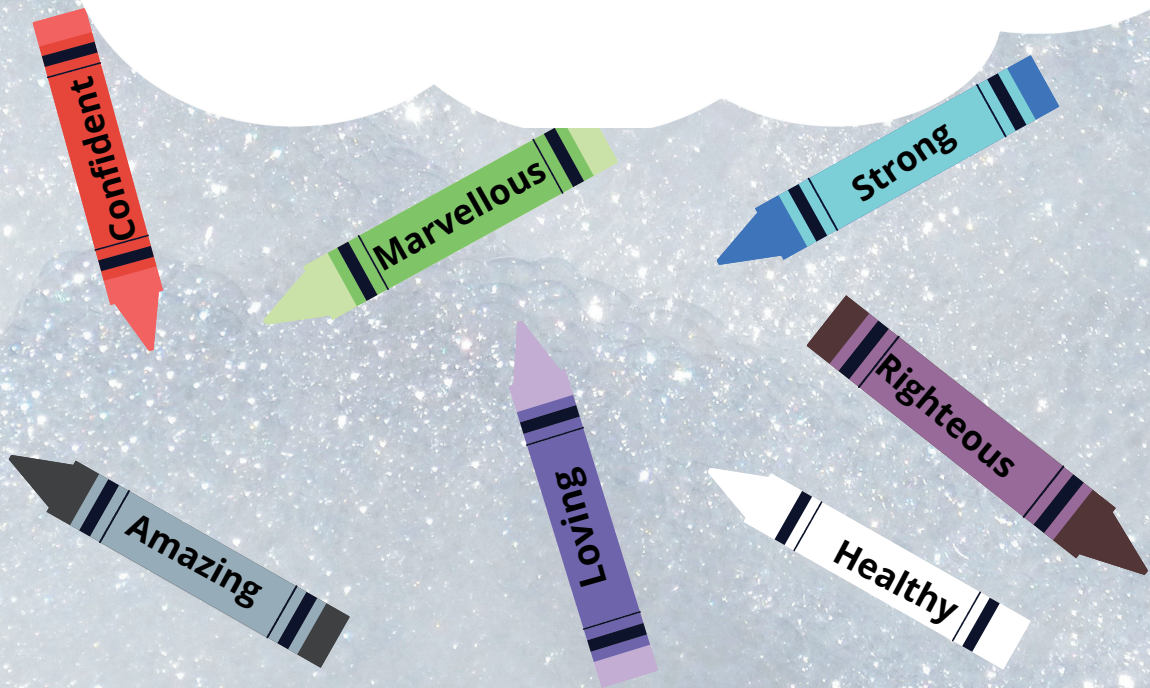

Coloring

On these pages, you will have fun scribbling with crayons while exploring new colors. You will also discover God's promises for you through the alphabets. Be sure to have pencils and crayons ready!



A a

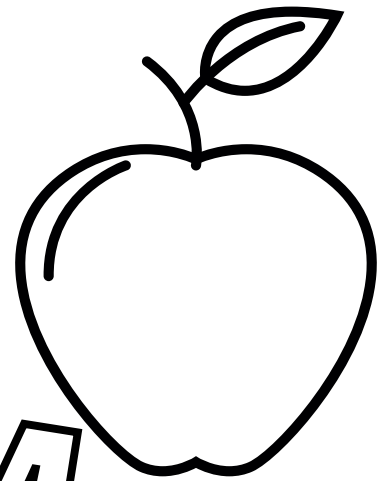
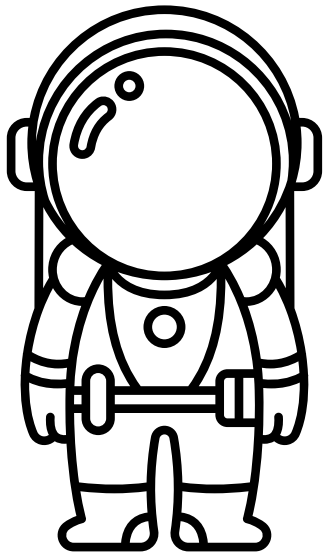
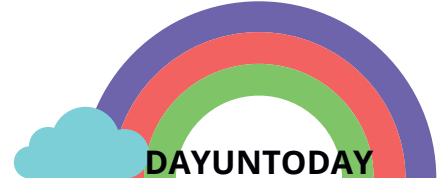

I AM

AWESOME

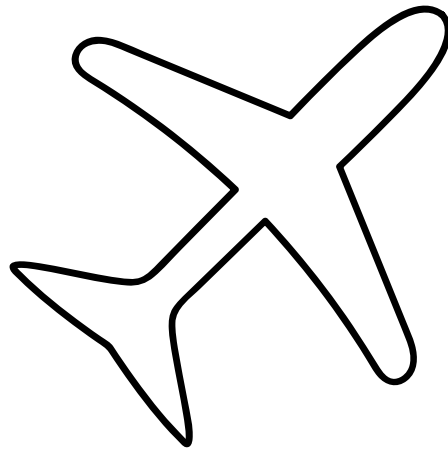

How awesome are your
deeds! So great is your power

PSALM 66:3

B b

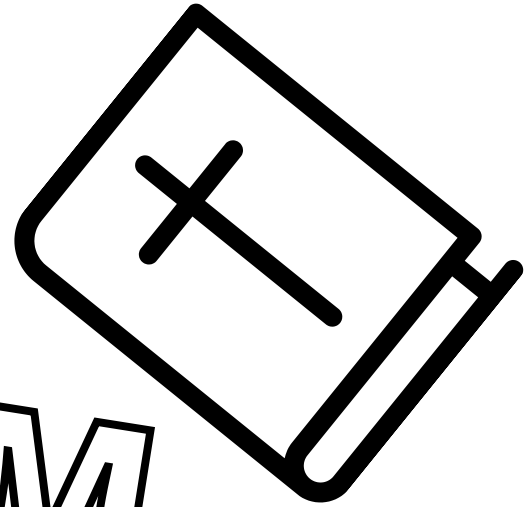
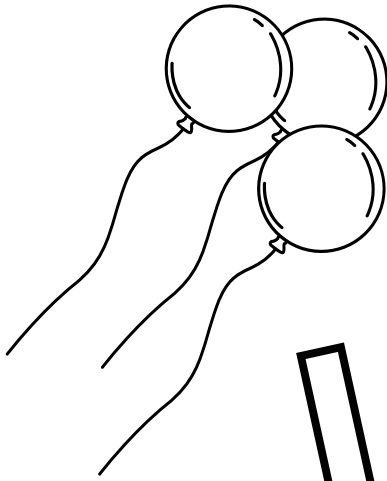
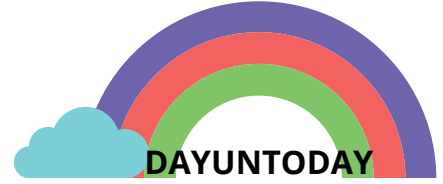

I AM

BOLD



The righteous are bold as a
Lion

PROVERBS 28:1

C c

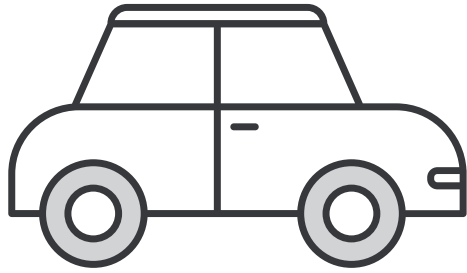

I AM
CONFIDENT

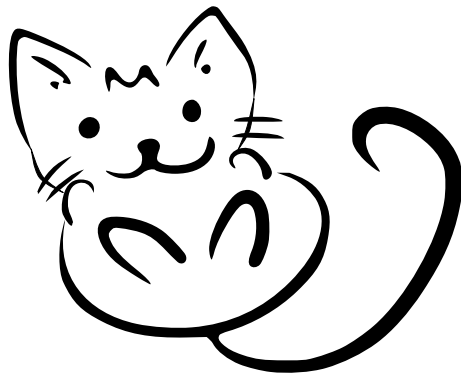

I am confident of this very
thing, he who started a good
work in you will complete it

PHILLIPIANS 1:6

D d

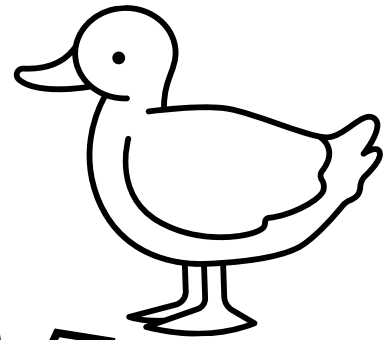
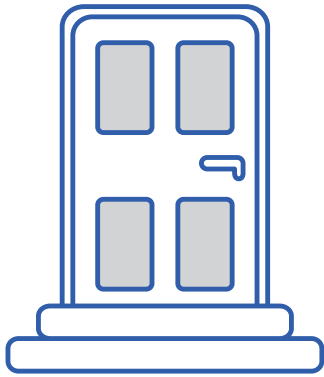
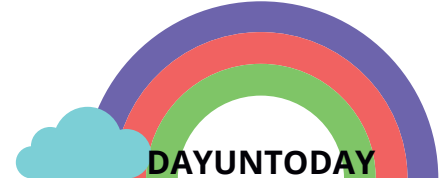

I AM
DISCIPLINED

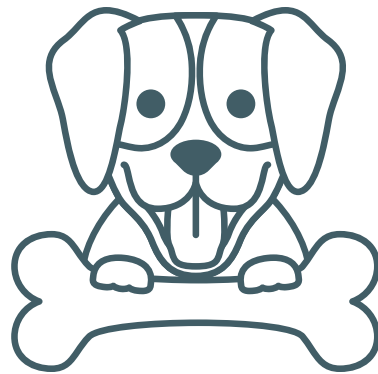

Whoever loves discipline
loves knowledge...
PROVERBS 12:1

E e

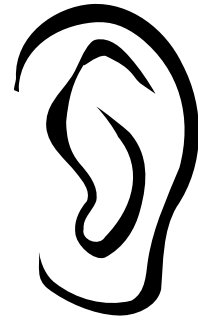
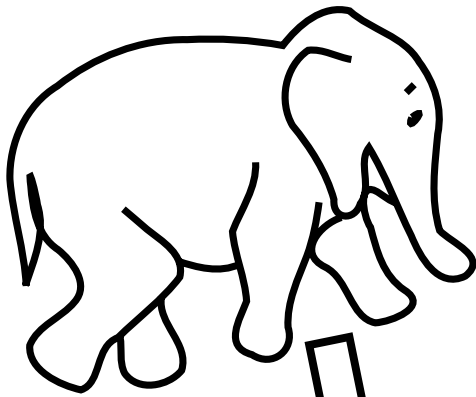
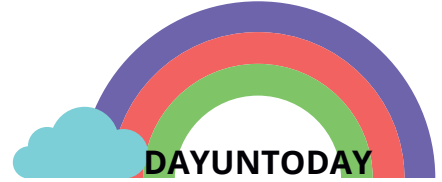

I HAVE
AN
EXCELLENT
SPIRIT

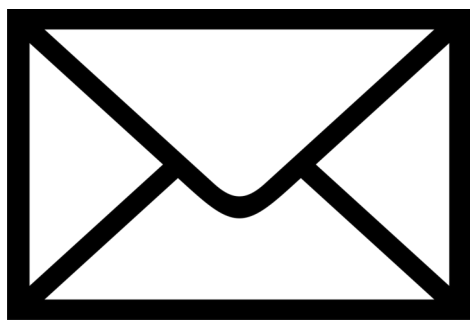

Do you see a man who
excels in his work? He will
stand before kings...

PROVERBS 22:29

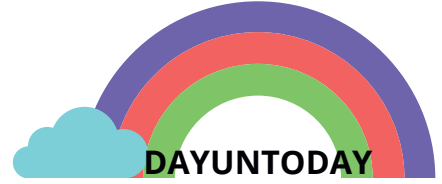

Trace and connect the letters

a

d

c

e

b

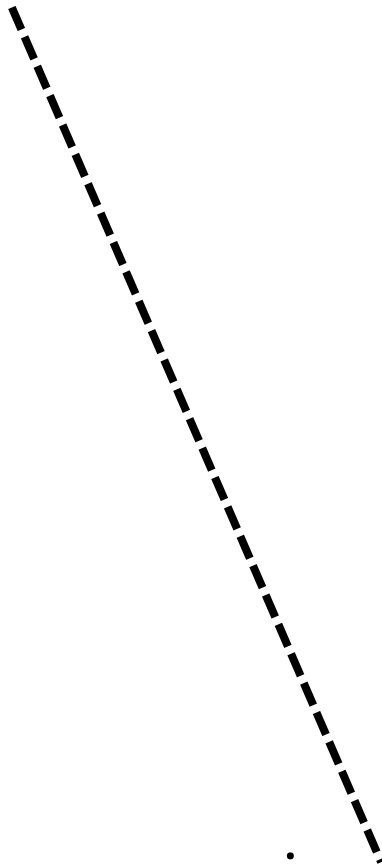

F f

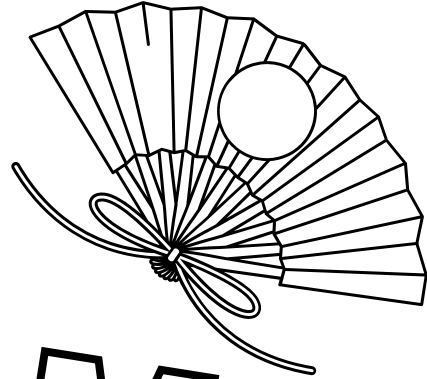
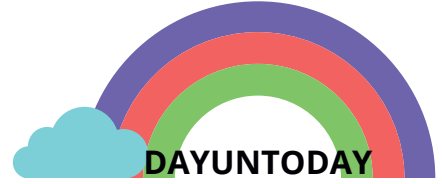

I AM
FEARLESS

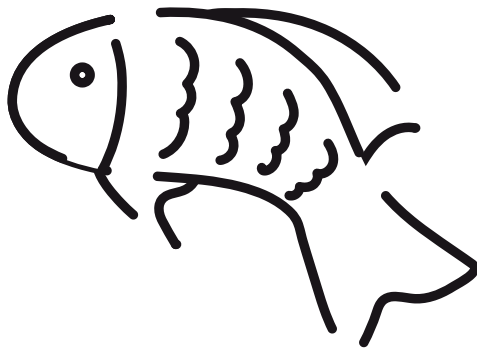

For God has not given us a
spirit of fear...
2 TIMOTHY 1:7

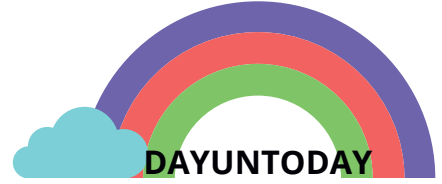

G g

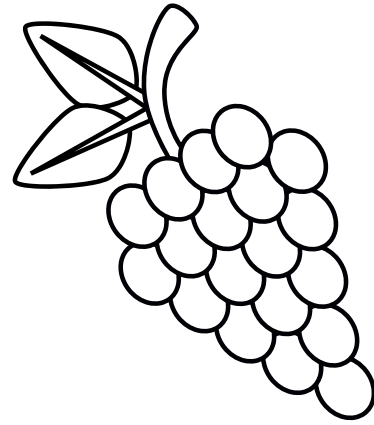
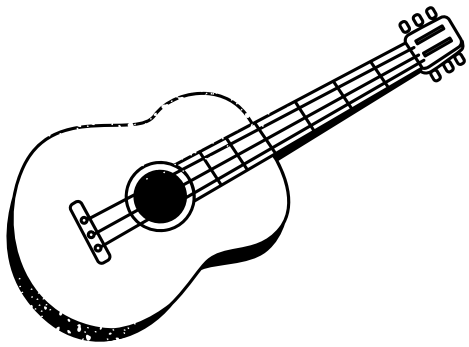

I AM A
GOOD GIFT

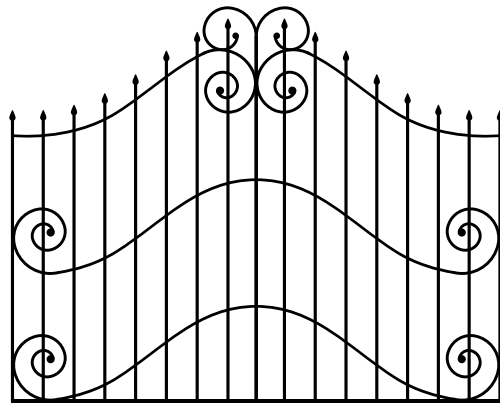

Every good gift is from
above...

JAMES 1:17

H h

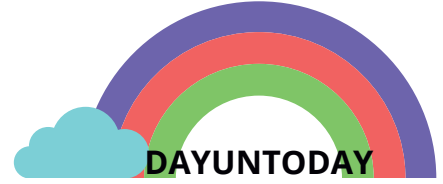

I AM A
GODLY
HERITAGE

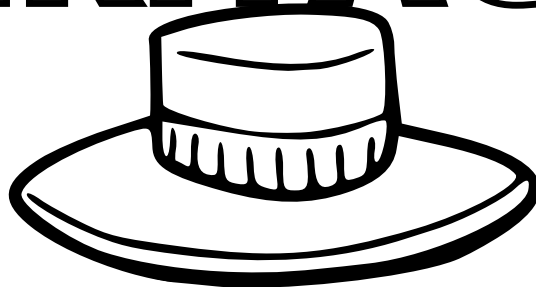

Behold children are a
heritage from the Lord...

PSALM 127:3

I i

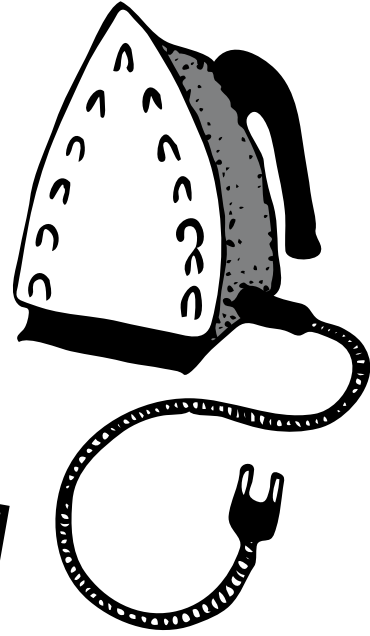
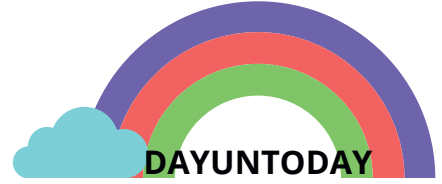

I AM

INTELLIGENT

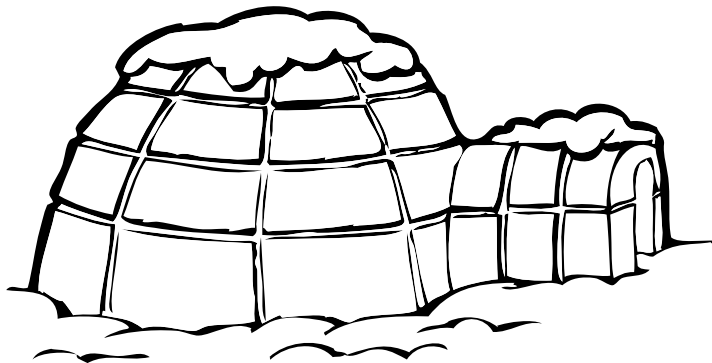

I have filled him with the Spirit of God, with ability and Intelligence.. EXODUS 31:3

زج

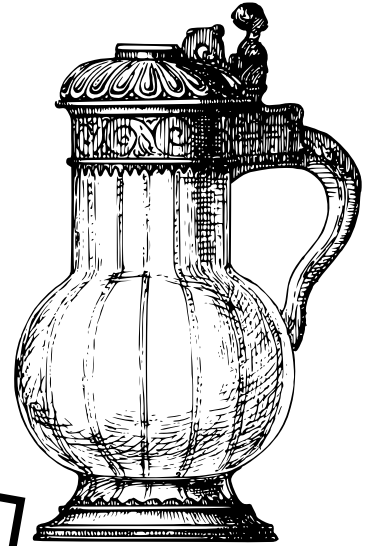
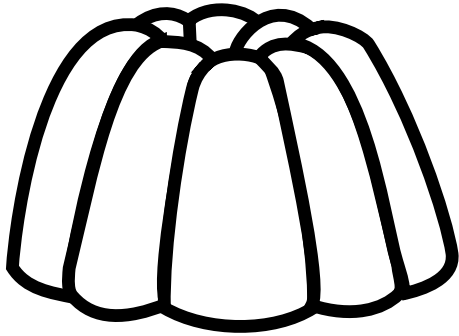
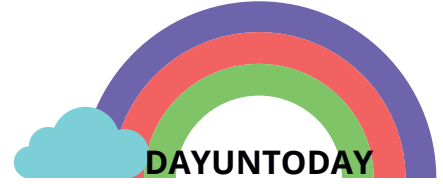

I AM
JOYFUL

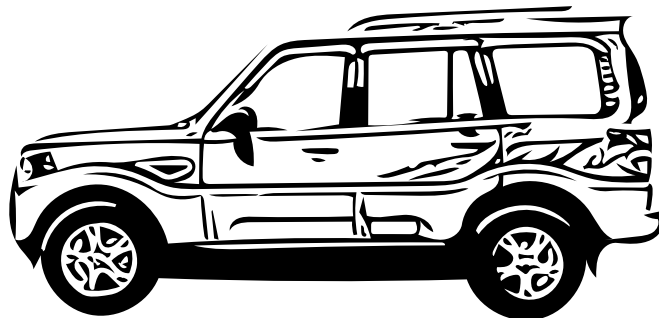

The Joy of the Lord is your
strength

NEHEMIAH 8:10

KK

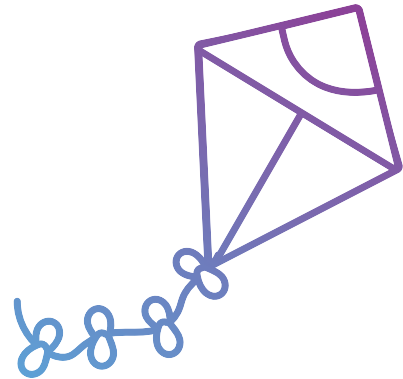
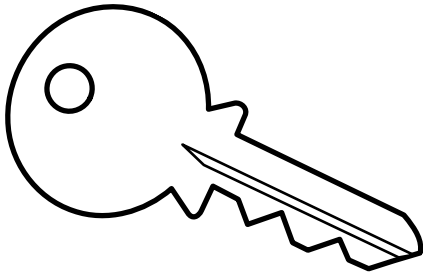
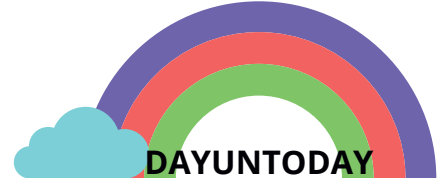

I AM
KIND

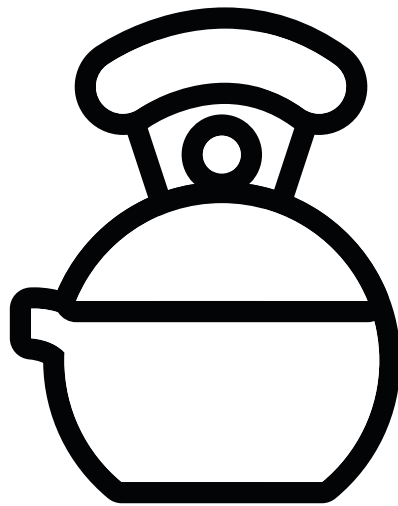

Be kind to one another...

EPHESIANS 4:32

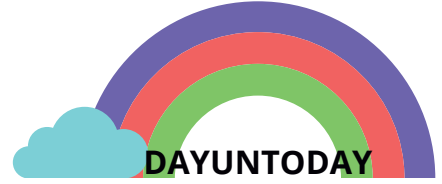

Trace and connect the letters

f

h

i

k

j

g

L I

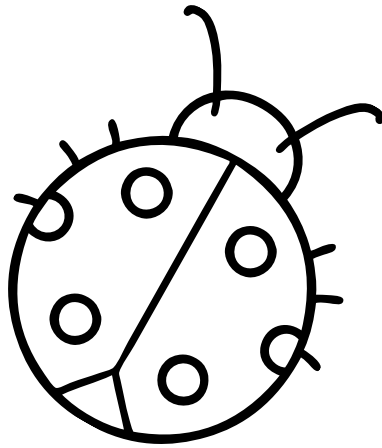

I AM THE
LIGHT
OF THE WORLD

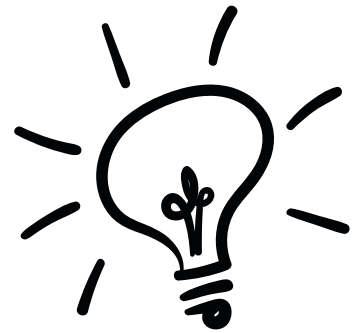

You are the light of the
world..

MATTHEW 5:14

M m

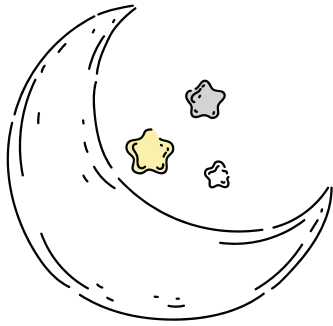
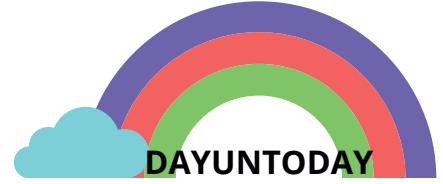

I AM
MAJESTIC

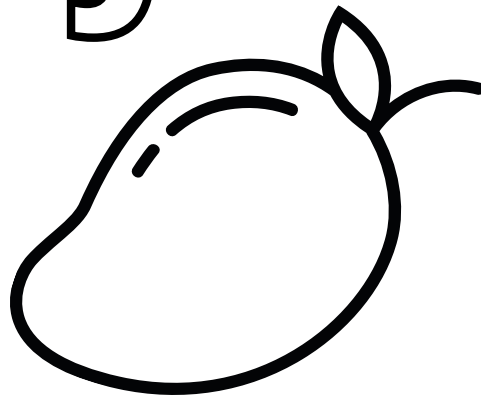

Oh Lord, our Lord how
Majestic is your name in all
the earth...

PSALM 8:1

N n

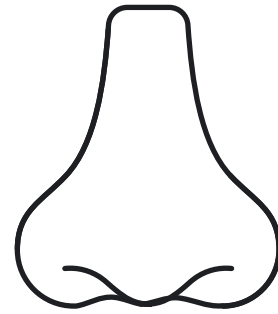
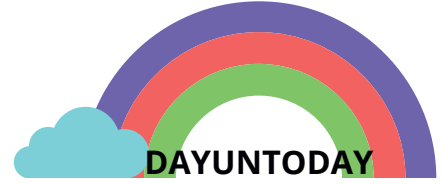

I AM
NOBLE



Finally brethren whatever
things are true, whatever
things are noble...think on
these things

PHILLIPIANS 4:8

0 0

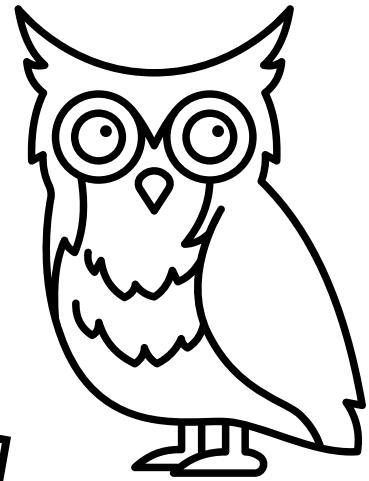
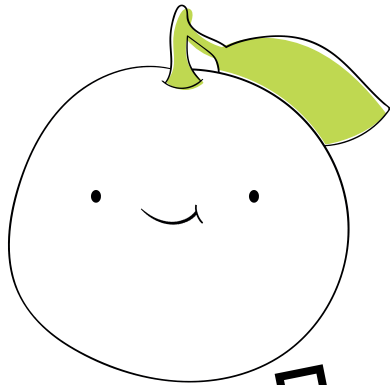
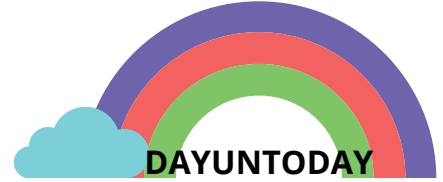

I AM
THE ONE



He left the ninety nine to
rescue the one(me)
MATTHEW 18:12

P p

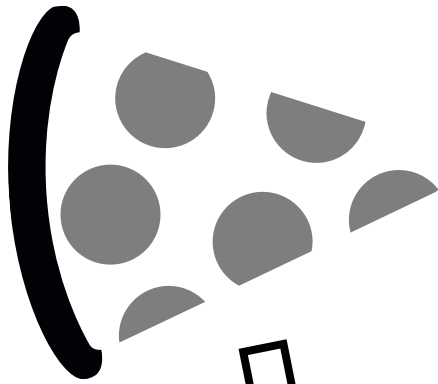
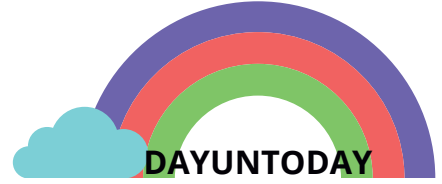

I AM
PATIENT



...Be patient bearing with
one another in love
EPHESIANS 4:2

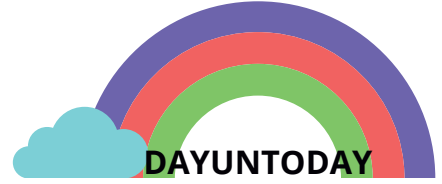

Trace and connect the letters

l

m

n

o

p

Q q

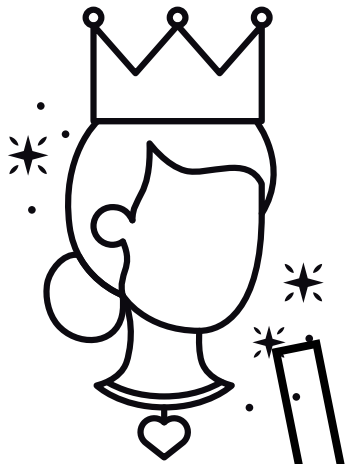
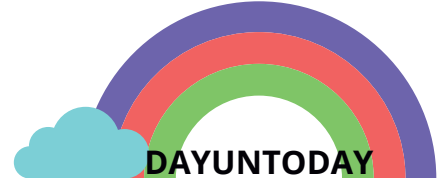

I AM
QUICK
MINDED



Behold I give you a wise and
discerning mind, so that
none like you has been
before you 1 KINGS 3:12

R r

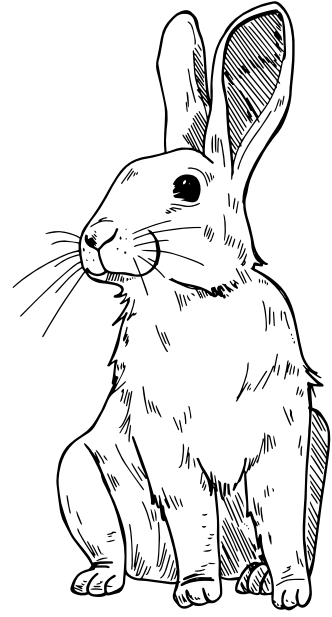
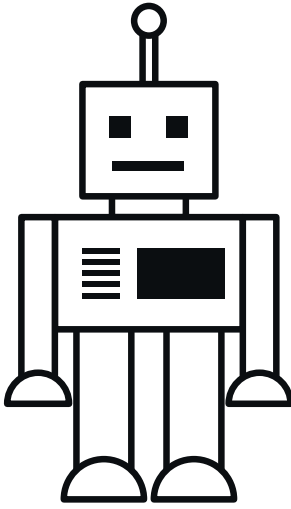
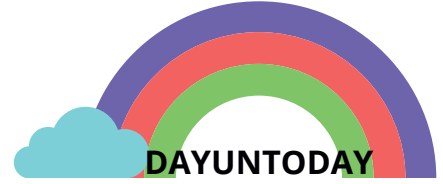

I AM
ROYALTY



But you are a chosen people,
a royal priesthood, a holy
nation...

1 PETER 2:9

ss

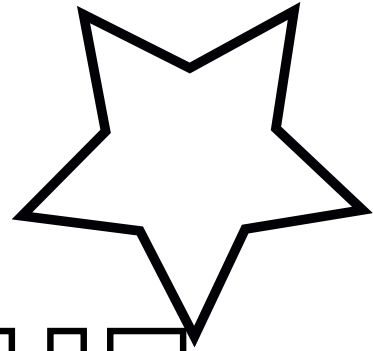
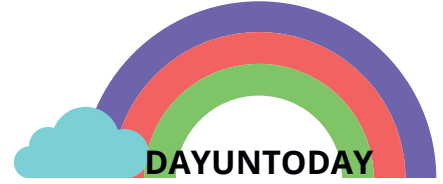

I AM THE
SALT
OF THE
EARTH



You are the salt of the earth
MATTHEW 5:13

T t

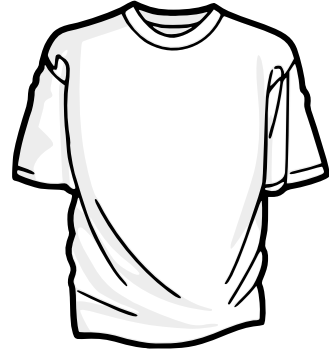
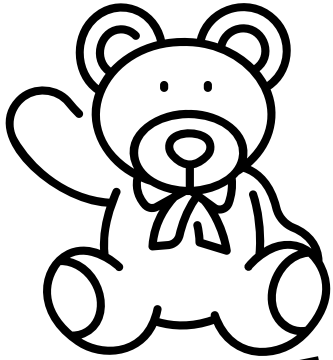
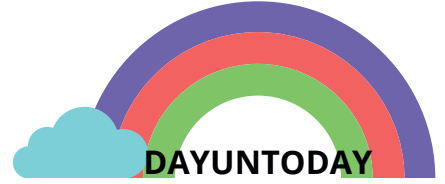

I AM
TALENTED



To one he gave five talents,
to another two, to another
one, to each according to his
ability MATTHEW 25:15

U u

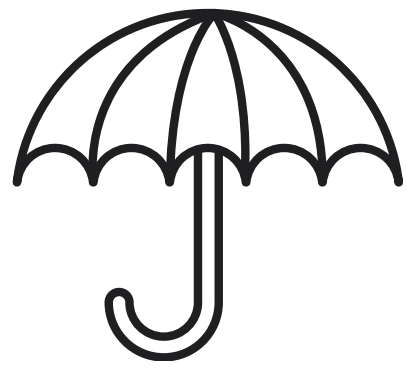
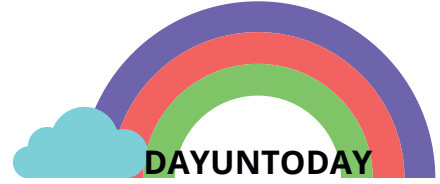

I AM
UNIQUE

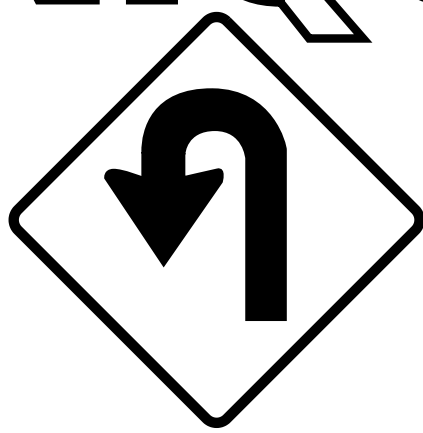

Before I formed you I knew
you, and before you were
born I consecrated you
JEREMIAH 1:5

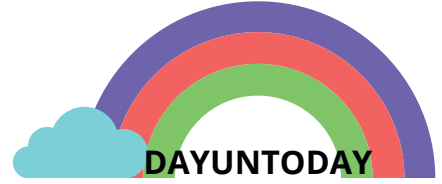

Trace and connect the letters

r

s

q

t

u

V v

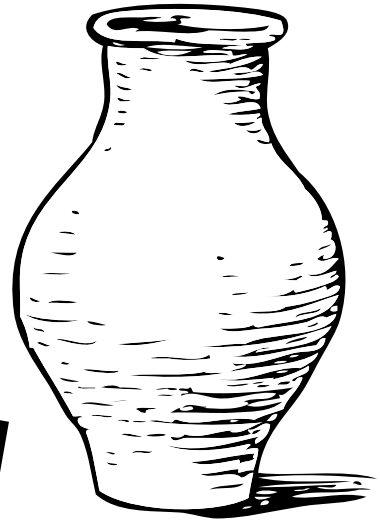
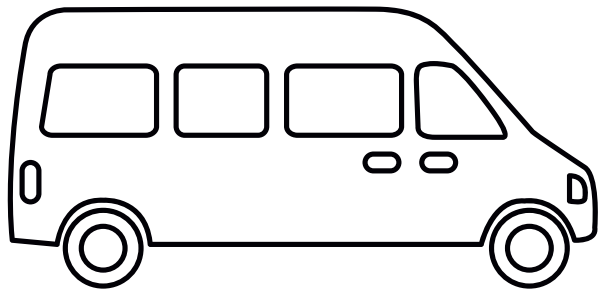
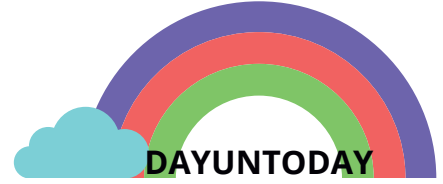

I AM
VALUED

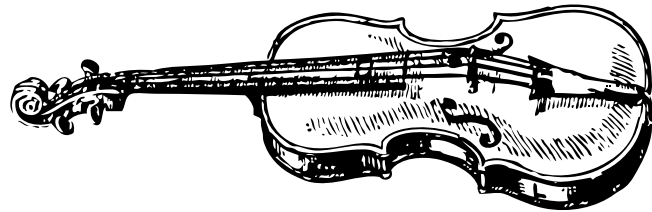

Godliness is of value in
every way
1 TIMOTHY 4:8

W w

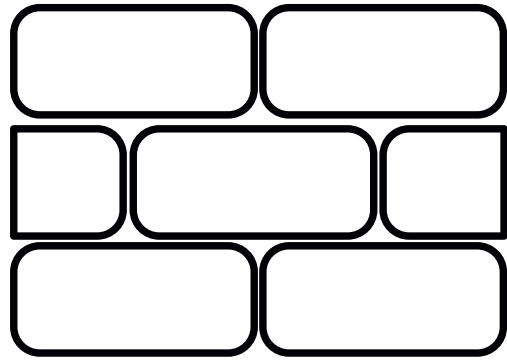
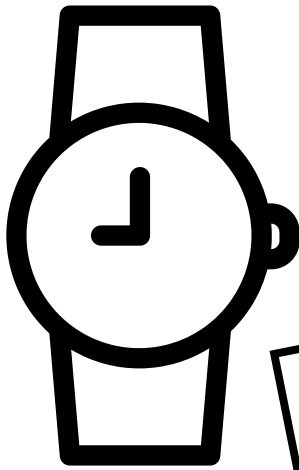
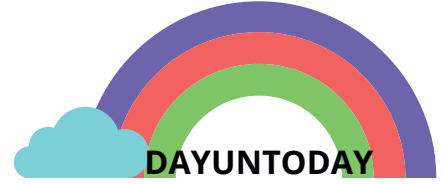

I AM
WONDERFULLY
MADE

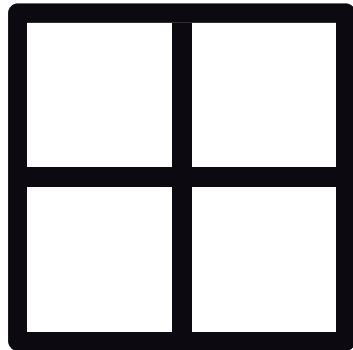

For I am fearfully and
wonderfully made
PSALM 139:14

X x

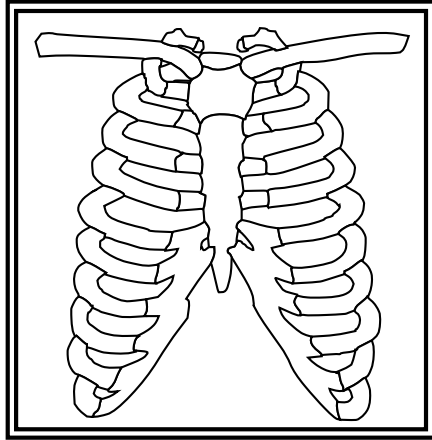

I AM
XTRA
ORDINARY

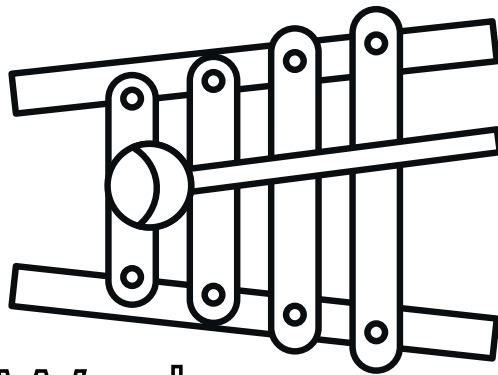

...We have seen
extraordinary things today

LUKE 5:26

y y

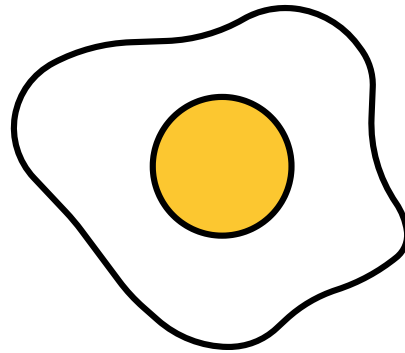

I AM
YOUTHFUL

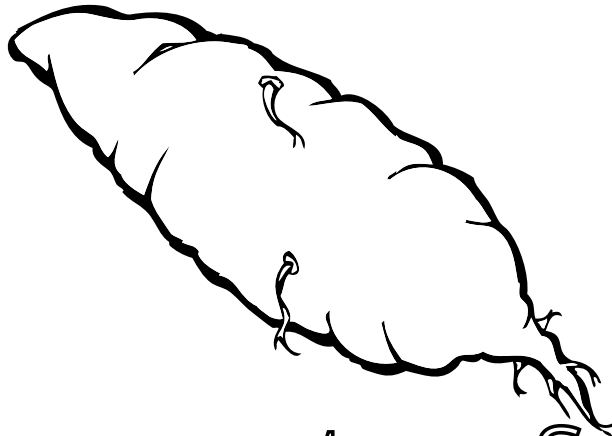

I will pour out my Spirit on
all flesh... and your young
men shall see visions

ACTS 2:17

22



I AM A
CITIZEN OF
ZION



Out of Zion, the perfection of
beauty, God will shine forth

PSALM 50:2

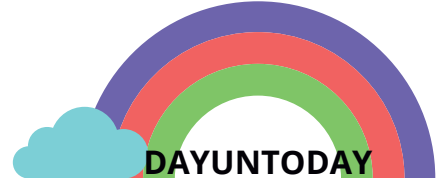

Trace and connect the letters

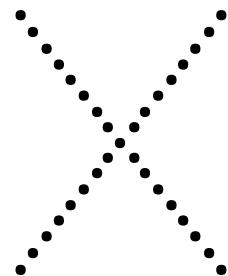
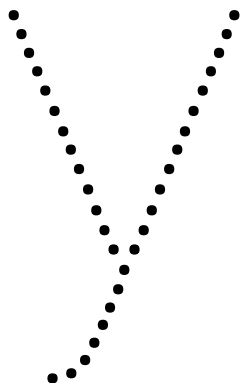
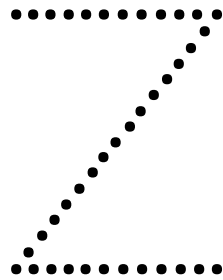
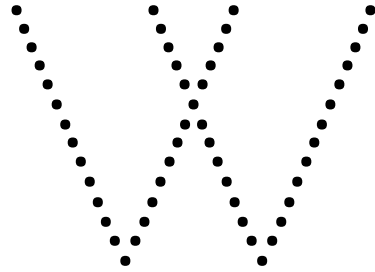
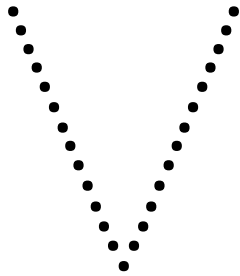

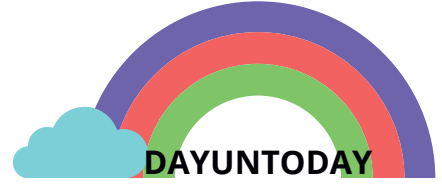

Dear Friend, I invite you to pray this prayer of salvation.

Dear God, I know that I have done wrong things. I ask that you forgive me and bring me in as part of your family. I believe with my heart that Jesus died for my sins and I confess with my mouth that Jesus is Lord.

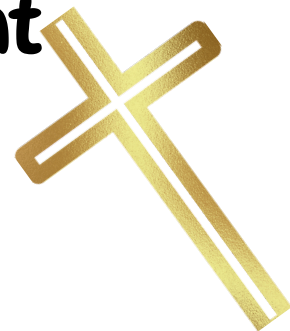

Name: _____

Date: _____